

- TOP QUALITY
- SEALED BACK

OIL LEVEL GAUGE

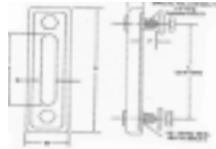

SIGHT GAUGE							ORDER INFORMATION		
L	H	W	C	E	F	G	REFERENCE	STOCK NUMBER	PRICE
5	6-5/8	2-1/32	23/32	3-7/8	3/4	13/16	550-5	LG00901	17.11
7	8-5/8	2-11/32	3/4	5-7/8	11/16	1	550-7	LG00903	26.77



- TOP QUALITY
- SEALED BACK

OIL LEVEL/TEMPERATURE SIGHT GAUGE

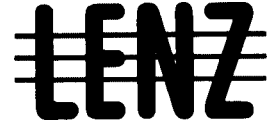

SIGHT GAUGE							ORDER INFORMATION		
L	H	W	C	E	F	G	REFERENCE	STOCK NUMBER	PRICE
3 1/4	4-13/16	2-1/32	23/32	2-7/32	3/4	25/32	T550-3	LG00895	18.90
5	6-5/8	2-1/32	23/32	3-7/8	3/4	13/16	T550-5	LG00900	18.73

Reservoir Flanges — Return

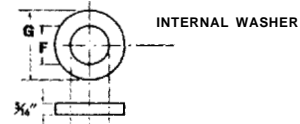

GENERAL INFORMATION

Return flanges are designed to accommodate the return pipe to the tank. The parts can be quickly and easily installed on tanks.



RESERVOIR FLANGE					ORDER INFORMATION	
PIPE SIZE	E	F	G	REFERENCE	STOCK NUMBER	PRICE
1/2"	1-7/16	53/64	3	HA-00-28-8P	GS00888	4.66
3/4"	1-7/16	1-1/32	3	HA-00-28-12-P	GS00890	4.66
1"	1-7/16	1-9/32	3	HA-00-28-16P	GS00891	4.66
1-1/4"	2-1/16	1-21/32	3	HA-00-28-20P	GS00892	4.66
1-1/2"	2-1/16	1-57/64	3	HA-00-28-24P	GS00893	4.66
2"	2-1/2	2-11/32	3	HA-00-28-32P	GS00894	4.66

Filler Breather Cap

GENERAL INFORMATION

5 times greater filter air flow than standard units. 200 GPM or 26.7 CFM. Keeps reservoir fluids clean, protects and prolongs hydraulic system life! Includes chain.

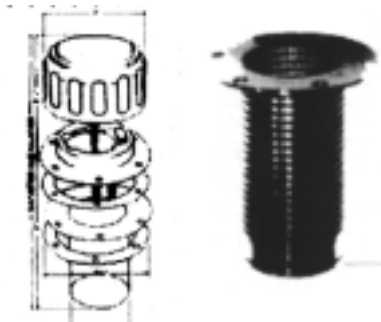

FILLER BREATHER CAP				ORDER INFORMATION	
FILTRATION	GPM	CFM	REFERENCE	STOCK NUMBER	PRICE
40 MICRON	200	26.7	57XL-40	LG01025	9.78

GRAND RAPIDS

TOLL FREE 1-800-968-0188
PHONE: (616) 949-8844
FAX: (616) 949-6598

KALKASKA

TOLL FREE 1-800-355-4338
PHONE: (616) 258-4338
FAX: (616) 258-2696

4-Bolt Solid Flanges

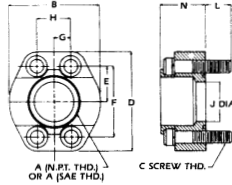
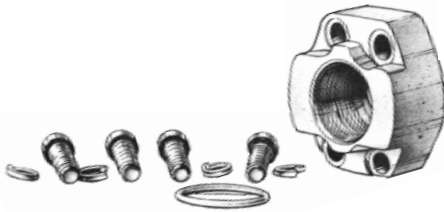

GENERAL INFORMATION

3000 psi internal pipe thread. Drilled holes. O-Ring. They are compatible with any SAE pumps or valves. They allow for removing pump or filter without disturbing piping.

4-BOLT FLANGE											ORDER INFORMATION		
A	B	C	D	E	F	G	H	J	L	N	REFERENCE	STOCK NUMBER	PRICE
3/4	2.06	3/8-16	2.56	.93	1.875	.43	.875	3/4	.53	1.25	HCFT-12-12	GS01000	19.60
1	2.31	3/8-16	2.75	1.03	2.062	.52	1.032	1	.66	1.38	HCFT-16-16	GS01015	21.22
1 1/4	2.88	7/16-14	3.12	1.16	2.312	.59	1.188	1 1/4	.84	1.50	HCFT-20-20	GS01030	24.50
1 1/2	3.25	1/2-13	3.69	1.38	2.75	.70	1.406	1 1/2	.73	1.62	HCFT-24-24	GS01045	27.74
2	3.81	1/2-13	4.00	1.53	3.062	.84	1.688	2	.73	1.62	HCFT-32-32	GS01060	35.90
2 1/2	4.28	1/2-13	4.50	1.75	3.50	1.00	2.00	2.50	.86	2.00	HCFT-40-40	GS01075	52.30
3	5.16	5/8-11	5.31	2.09	4.188	1.22	2.438	3.00	.98	2.25	HCFT-48-48	GS01090	71.70

Reservoir Flanges — Suction

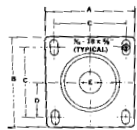
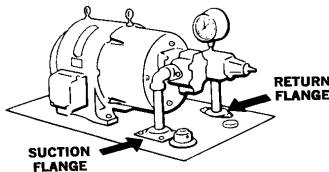

INTERNAL WASHERS

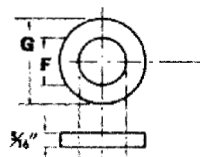

GENERAL INFORMATION

Suction flanges are designed for the suction pipe line of the reservoir and are installed on top of the tank as shown in the left diagram.

SUCTION FLANGE								ORDER INFORMATION		
PIPE SIZES	A	B	C	D	E	F	G	REFERENCE	STOCK NUMBER	PRICE
1/2"	5-1/4	5-1/2	4-1/4	2-1/8	1-7/16	5-3/64	3	HA-00-04-8P	GS00896	6.90
3/4"	5-1/4	5-1/2	4-1/4	2-1/8	1-7/16	1-1/32	3	HA-00-40-12P	GS00890	6.90
1"	5-1/4	5-1/2	4-1/4	2-1/8	1-7/16	1-9/32	3	HA-00-40-16P	GS00898	6.90
1-1/4"	5-1/4	5-1/2	4-1/4	2-1/8	2-1/16	1-21/32	3	HA-00-40-20P	GS00900	6.90
1-1/2"	7-1/4	7-1/2	6-1/4	3-1/8	2-1/16	1-57/64	3	HA-00-60-24P	GS00920	19.00
2"	7-1/4	7-1/2	6-1/4	3-1/8	2-1/2	2-11/32	3	HA-00-60-32P	GS00922	19.00
2-1/2"	7-1/4	7-1/2	6-1/4	3-1/8	3-1/16	2-27/32	4-1/4	HA-00-60-40P	GS00925	19.00
3"	7-1/4	7-1/2	6-1/4	3-1/8	3-3/4	3-15/32	4-1/4	HA-00-60-48P	GS00930	19.00

GRAND RAPIDS

TOLL FREE 1-800-968-0188
PHONE: (616) 949-8844
FAX: (616) 949-6598

KALKASKA

TOLL FREE 1-800-355-4338
PHONE: (616) 258-4338
FAX: (616) 258-2696